



CLEANROOM

GRID, RECESSED
FLUSH WITH T-GRID, EXTRUDED LENS FRAME
FLUORESCENT TROFFER

1' X 2'

APPLICATIONS

- Cleanrooms
- Food processing centers
- Hospitals
- Pharmaceutical and Biological labs
- Wet Locations

Totally sealed housings with Flush with Grid Lens Frames, silicone set lenses, sealed flat head screws, and uniform lighting make CGB Series ideally suited for CLEANROOM, Hospital, Food processing, and Scientific lab areas, where contamination free environment is a must.

FEATURES

- ♦ Sealed, painted white, 20 gauge Housing seals to grid
- ♦ 1' X 2' nominal Housing size
- ♦ Works with 1", 1 1/2" and 2" inverted "T" ceiling grid
- ♦ Lens Frame is flush with T Grid and seals to Housing
- ♦ Lens is silicone sealed to extruded Lens Frame
- ♦ Gasketed Access Plate
- ♦ Low brightness Lens installed smooth side to room
- ♦ Sealed, captive flat head Screws (4)
- ♦ Manufactured in accordance to NSF, FDA, USDA and Federal Standard 209D

CROSS SECTION

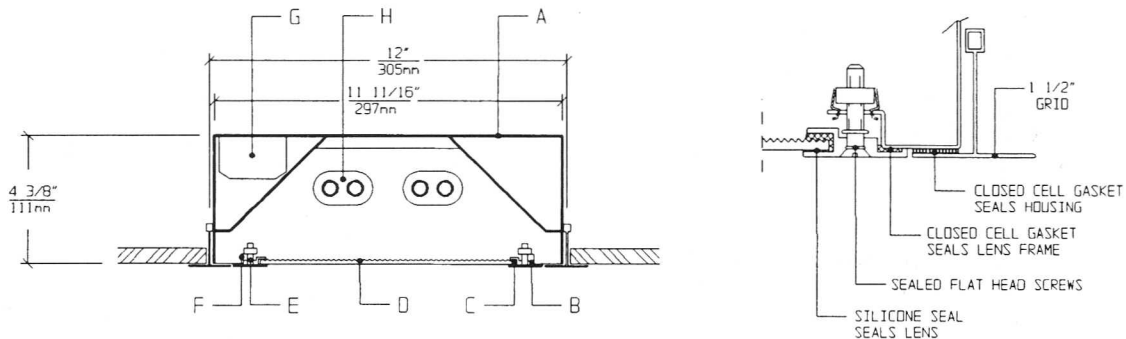

LENS FRAME DIMENSIONS

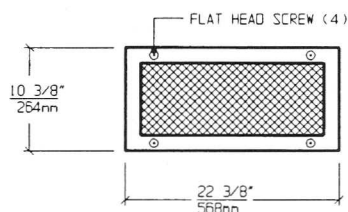

TOP VIEW

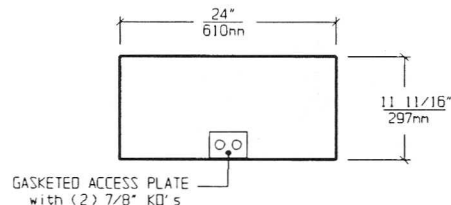

SPECIFICATIONS

A. HOUSING	Die formed 20 gauge cold rolled steel Housing, with welded seams. Painted white.	F. HINGE	Two "shadow free" detachable chains for ease of installation and maintenance.
B. LENS FRAME	Heavy aluminum extrusion with sealed, mitered corners. Painted white to match Grid.	G. BALLAST	HPF, Class P, Energy saving Ballast (See Voltage, Ballast Options).
C. GASKET	Closed cell gaskets and silicone seal prevent air and contaminants from entering the room.	H. LAMPS	17W T-8, 20W T-12 or 40W Biax Twin Tube Lamps. See Lamp Options. (Lamps by others).
D. LENS	Low brightness Lens with prisms up and smooth side to room for ease of cleaning. (See Options).	I. FINISH	Polyester Powder coat white finish with 92% reflectance.
E. FASTENERS	Sealed, flush, captive stainless steel screws apply even pressure against Lens Frame.	J. UL LISTED	Suitable for Wet Locations.

LAMP SELECTION

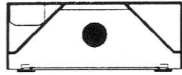

LAMPS: (1) 17W T-8
(1) 20W T-12

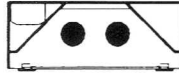

LAMPS: (2) 17W T-8
(2) 20W T-12

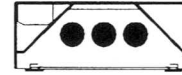

LAMPS: (3) 17W T-8
(3) 20W T-12

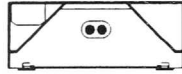

LAMPS: (1) 40W BIAx

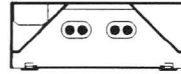

LAMPS: (2) 40W BIAx

ORDERING INFORMATION

CGB - 12 -

No. of LAMPS	WATTAGE	VOLTAGE	BALLAST	LENS OPTION	OPTIONS
1=1 Lamp	17=17 Watts	120=120 Volts	EB=Electronic	12PA=.125"Prism. Acrylic	TP=Tamperproof screws
2=2 Lamps	(T- 8)	277=277 Volts	Ballast	15PA=.156"Prism. Acrylic	GF=GLR Fuse
3=3 Lamps	20=20 Watts		MB=Magnetic	15PG=.156"Prism. Glass	NL=Night Light(PL-7or 9)
(T lamps only)	(T-12) 40BX=40 Watts Biax Twin Tube		Ballast	18CP=.187"Clear P/C UO = UV Absorbing Overlay	DB=Dimming Ballast EM=Emergency Lighting CW=Cold Weather Ballast
				(Other Lens Options available. Consult Factory)	RF=Radio Frequency Interference Filter AH=Aluminum Housing SH=Stainless Steel Housing
					(More than one Option can be specified)

EXAMPLE: CGB - 12 - 2 - 40BX - 277 - EB - 12PA - GF - NL

DESCRIPTION: CGB-12 = Series CGB, 1 foot by 2 feet nominal size
 2 = 2 Lamps
 40BX = 40 Watts Biax Twin Tube
 277 = 277 Volt Operation
 EB = Electronic Ballast
 12PA = .125" Thick Prismatic Acrylic
 GF = GLR Fuse
 NL = Night Light for PL - 7 or 9

FIXTURE TYPE	COMMENTS
CATALOG NUMBER CGB-12-	
JOB NAME	
APPROVAL	
DATE	

Dimensions and Specifications subject to change without notice
 Fixture guaranteed for one year against mechanical defects in manufacture.
 5-95 CGB-12